

SPALDING®

#TRUEBELIEVERS ARE TRUE TO THE GAME®



2019 * Pricing valid until 30/06/2019





Buva Sports NV, Karrewegstraat 104, 9800 Deinze - Belgium 0032 9 3868744 catherine@buvasport.com



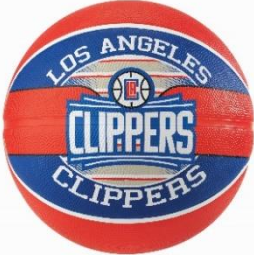

SPALDING 2019

| | | | | | | | | | |
|---|--------------------------|---|-----------|--|---------------------------------|---|-----------------------------|---|-----------------------------|
|  | |  | |  | |  | |  | |
| | | NEW ADVANCED ECO GRIP | | | | | | | |
| CODE | 302 / 74450 | CODE | 76293 | CODE | 76018 | CODE | 83494 | CODE | 83568 |
| SPECS | TF 1000 LEGACY INDOOR | SPECS | PRECISION | SPECS | NBA SILVER SERIES IN/OUTDOOR | SPECS | NBA SILVER SERIES RUBBER | SPECS | NBA SILVER SERIES RUBBER |
| SIZE | 7 | SIZE | 7 | SIZE | 7 | SIZE | 7 | SIZE | 5 |





| | | | | | | | | | |
|---|--------------------------|--|----------------------|---|--------------------------|--|----------------------|--|-------------------|
|  | |  | |  | |  | |  | |
| | | | | | | NEW SIZE 6 | | | |
| CODE | 74496 | CODE | 74584 | CODE | 83192 | CODE | 74532 / 74537 | CODE | 73953/73954/73955 |
| SPECS | TF 1000 LEGACY INDOOR | SPECS | TF 250 IN/OUTDOOR | SPECS | NBA LOGOMAN SOFT GRIP | SPECS | TF 250 IN/OUTDOOR | SPECS | TF 150 OUTDOOR |
| SIZE | 6 | SIZE | 6 | SIZE | 7 | SIZE | 6 / 5 | SIZE | 7 / 6 / 5 |

SPALDING 2019

| | | | | | | | | | |
|--|---------------|---|-------------|--|---------------|---|---------------|---|----------------|
|  | |  | |  | |  | |  | |
| NEW - OCTOBER TEAM BALL | | TEAM BALL | | TEAM BALL | | TEAM BALL | | TEAM BALL | |
| CODE | 83510 / 83585 | CODE | 83506 | CODE | 83515 / 83587 | CODE | 83503 / 83583 | CODE | 83504 / 83584 |
| SPECS | LA LAKERS | SPECS | LA CLIPPERS | SPECS | GS WARRIORS | SPECS | CHICAGO BULLS | SPECS | CLEVELAND CAVS |
| SIZE | 7 / 5 | SIZE | 7 | SIZE | 7 / 5 | SIZE | 7 / 5 | SIZE | 7 / 5 |

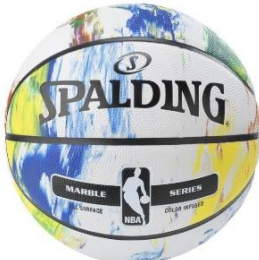
| | | | | | | | | | |
|--|------------|--|----------------|---|---------------|--|---------------|--|--------------|
|  | |  | |  | |  | |  | |
| TEAM BALL | | NEW TEAM BALL | | PLAYERS BALL | | PLAYERS BALL | | NEW PLAYERS BALL | |
| CODE | 83508 | CODE | 83505 | CODE | 83343 / 83400 | CODE | 83344 | CODE | 83863 |
| SPECS | CH HORNETS | SPECS | BOSTON CELTICS | SPECS | STEPHEN CURRY | SPECS | ANTHONY DAVIS | SPECS | LEBRON JAMES |
| SIZE | 7 | SIZE | 7 | SIZE | 7 / 5 | SIZE | 7 | SIZE | 5 |

SPALDING 2019





| | | | | | | | | | |
|---|---------------|---|------------|--|-------------------|---|-----------|---|----------------|
|  | |  | |  | |  | |  | |
| NEW | | | | | | | | | |
| CODE | 73849 | CODE | 83636 | CODE | 83641 | CODE | 76039 | CODE | 83649 |
| SPECS | TF 33 OUTDOOR | SPECS | NBA MARBLE | SPECS | EXTREME SOFT GRIP | SPECS | THE SNAKE | SPECS | NBA LOGO ICONS |
| SIZE | 6 | SIZE | 7 | SIZE | 7 | SIZE | 7 | SIZE | 7 |





| | | | | | | | | | |
|---|-------------------|--|---------------|---|-------------|--|-------------|--|------------|
|  | |  | |  | |  | |  | |
| NEW | | NEW | | NEW | | NEW JULY 2019 | | | |
| CODE | 83826 | CODE | 83832 / 83830 | CODE | 83951 | CODE | 83875 | CODE | 83047 |
| SPECS | NBA TRIPLE THREAT | SPECS | NBA MVP | SPECS | ROOKIE GEAR | SPECS | MARBLE 4HER | SPECS | JUNIOR NBA |
| SIZE | 7 | SIZE | 7 / 5 | SIZE | 4 | SIZE | 6 | SIZE | 5 |

SPALDING 2019 MICRO MINI





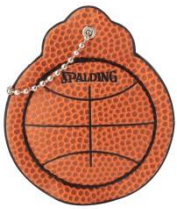

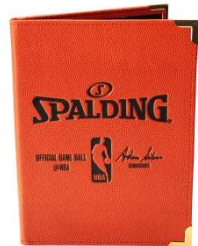
| | | | | | |
|---|---------|--|--------|---|-------|
|  | |  | |  | |
| CODE | 77651 | CODE | 77656 | CODE | 77602 |
| | CELTICS | | LAKERS | | NBA |

SPALDING 2019 TRAINING AIDS & ACCESSORIES

| | | | | | | | | | |
|---|---------------|---|------------------|--|----------------|---|---------------|---|--------------|
|  | |  | |  | |  | |  | |
| CODE | 8490 | CODE | 8479 | CODE | 8481 | CODE | 8478 | CODE | 8488 |
| SPECS | POWER DRIBBLE | SPECS | LATERAL RESISTOR | SPECS | DRIBBLE GOGGLE | SPECS | JUMP STRENGTH | SPECS | POP-UP GUARD |

| | | | | | | | | | |
|---|----------------|--|----------------|--|--------------------|---|----------------------------|--|----------------------------|
|  | |  | |  | |  | |  | |
| CODE | 8476 | CODE | 8484 | CODE | 68531 | CODE | 68532 | CODE | 68538 |
| SPECS | SHOOTING SPOTS | SPECS | SHOT CONTESTOR | SPECS | SPALDING KEY CHAIN | SPECS | SPALDING NBA CHANGE HOLDER | SPECS | PORTFOLIO SPALDING 5" X 7" |

SPALDING 2019

| | | | | | | | | | | | |
|---|----------------------|---|----------------|---|----------------|---|----------------|---|--------------------------|---|------------------|
|  | |  | |  | |  | |  | |  | |
| CODE | # 8235 | CODE | # 8324 | CODE | # 8391 | CODE | 56103 | CODE | # 8333 | CODE | # 8406 |
| SPECS | HEAVY DUTY NET WHITE | SPECS | POWER PUMP 12" | SPECS | COACHING BOARD | SPECS | NBA ARENA SLAM | SPECS | NEEDLES blister 3 pieces | SPECS | MOUNTING BRACKET |

SPALDING PORTABLE SYSTEMS 2019



| | |
|--|--|
| CODE | # 75746 |
| SPECS | NBA GOLD SYSTEM |
|  | <ul style="list-style-type: none"> •137 cm ACRYLIC backboard with heavy duty steel frame and boardpad • H-frame board mount construction • 35.6 cm heavy duty steel PRO SLAM breakaway rim • ExactaHeight lift provide accurate height adjustments from 2.28 to 3.05 m (15cm) • 3 pcs , 9cm diameter pole system • 140 L base sand or water filled tank |
| | |
| | |

| | |
|---|--|
| CODE | # 75761 |
| SPECS | NBA SILVER SYSTEM |
|  | <ul style="list-style-type: none"> •132 cm ACRYLIC backboard with heavy duty steel frame and boardpad • H-frame board mount construction • 35.6 cm heavy duty solid steel PRO SLAM breakaway rim • Lift system : proglide(2m28 – 3m05) • 3 pcs , 9cm diameter pole with pole pad • 140 l base sand or water filled tank |
| | |
| | |

| | |
|---|---|
| CODE | # 88596 |
| SPECS | NBA SILVER IN-GROUND |
|  | <ul style="list-style-type: none"> •112 cm POLYCARBONATE backboard with heavy duty steel frame and boardpad • H-frame board mount construction • 35.6 cm heavy duty solid steel SLAM JAM breakaway rim • Lift system: ratchet (2m28 -3m05) • 3 pcs , 9cm diameter pole |
| | |
| | |

SPALDING PORTABLE SYSTEMS 2019



JULY 2019

CODE # 61774

SPECS NBA ALLEY-OOP

- *Instahoop technology; no tools required
- *Composite board 112cm
- *Solid steel rim
- Lift system : telescoping 2.28 to 3.05 m
- 3 pcs , 7.62cm diameter vertical pool
- 96 l base, water or sand filled tank



CODE # 80798

SPECS COMBO HIGHLIGHT

- 112 cm composite backboard
- Standard solid rim
- White All weather net



CODE # 7801

SPECS PRO SLAM RIM

- 35.6 cm heavy duty solid steel
- Ultra smooth spring action
- White All weather net

SPALDING®

#TRUEBELIEVERS ARE TRUE TO THE GAME®

